

SPECIFICATIONS

Dimensions: 206 x 67 cm
 Weight: 106 kg
 Height adjustment: ± 47 – 97 cm
 Lifting capacity: Max. 200 kg
 Mains voltage: 100 - 240 VAC, 50 - 60 Hz
 Current: Max. 3.0 A
 Standby power consumption: Max. 3 W
 Insulation: Class II
 Device Classification I
 Applied parts Type BF
 Humidity proof: IP22

Motor force: 8 kN
 Motor usage: Max. 2 minutes/ 18 minutes off
 Hydraulic pump: 10 kN
 Frame material: Steel frames
 Frame finish: Powder coated white RAL 9016
 Conformity: IEC/EN 60601-1:2013 ed. 3.1
 IEC/EN 60601-2: 2015 ed. 4.0
 93/42/EEC
 WEEE
 RoHS2
 Warranty: 3 years, Classique upholstery 1 year

FUNCTIONALITY/ DIMENSIONS

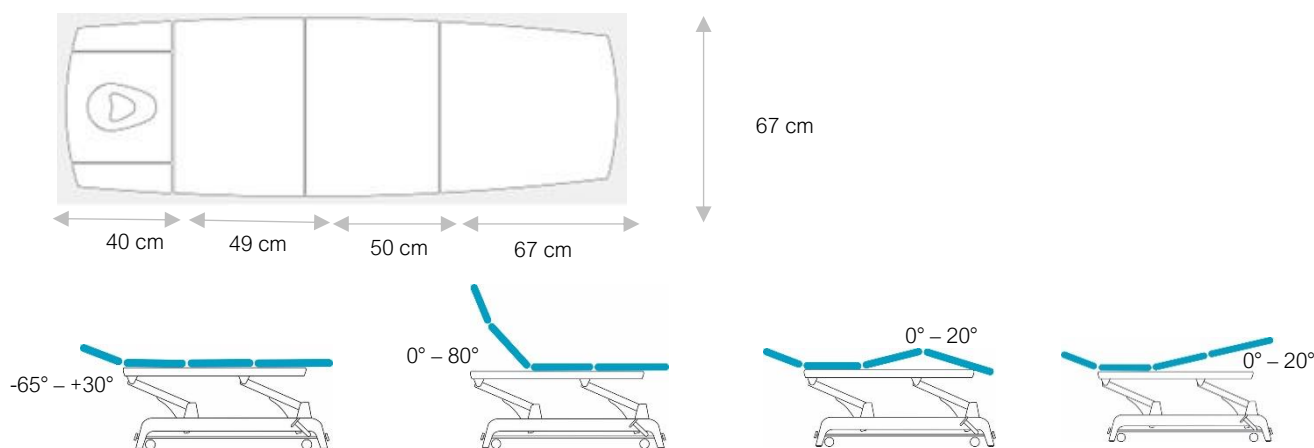

CUSHIONS UPHOLSTERY

Classique: PVC, phthalate free, biocompatible, abrasion resistant and flame retardant.
 Premium: PU, phthalate free, biocompatible, abrasion resistant and flame retardant.

CUSHIONS FINISH

Linear: Single padded, 40 kg/m³
 Progressive: Dual padded, 100 kg/m³ and 40 kg/m³

OPTIONS

Ergomax: PU foam, closed skin, low density 5° Shore
 Cushion heating: 34 °C, 36 °C and 38 °C
 Bluetooth wireless operation
 Automatic timer 30 minutes
 Maximum consumption = 180 W
 Battery function: Li-ion 25,9 VDC, 2,25 Ah

Memory function: Three programmable settings for height adjustment
 Bluetooth wireless operation
 LED Pack: Chassis illumination 14 colours, including brightness control
 Power consumption = 10 W
 Safe Motion Detection: Power consumption = 1 W